



SVETLED



SVL5630 Datasheet
Date of Publish June 2013

General Information

Features

- Package type: SMD 5630
- Based on InGaN on sapphire
- Viewing angle: 120°
- High efficiency: 179 lm/W @ 65 mA, 167 lm/W @ 120 mA
- RoHS compliant

Applications

- Office lighting
- Retrofit lamps
- Interior automotive lighting
- Backlighting

Product Code

SVL5630-FXX-XXX-VX

SVL5630 – Package Type

FXX – Flux Group

XXXX – CCT Group

VX – Voltage Group

Example: SVL5630-F50-50A50D-V2

Contents

3	Maximum Ratings
3	Optical Characteristics
4	Brightness Groups
4	Voltage Groups
5	CCT Groups
5	Cool White
6	Neutral White
7	Warm White
8	Package Dimensions
8	Solder Pad Design
9	Relative Luminous Flux vs Forward Current
9	Forward Current vs Forward Voltage
10	Relative Luminous Flux vs Junction Temperature
10	Forward Voltage vs Junction Temperature
11	Spectral Characteristics
11	Radiation Characteristics
12	Chromaticity Coordinates Shift vs Forward Current
12	Chromaticity Coordinates Shift vs Junction Temperature
13	Reflow Soldering Profile
14	Packing Information
15	Cautions



SVETLED

Maximum Ratings

Parameter	Symbol	Values	Unit
Forward Current	I_f	200	mA
Pulse Forward Current ($t \leq 10 \mu\text{s}$; $D = 0.005$; $T_j = 25 \text{ }^\circ\text{C}$)	I_{fp}	500	mA
Reverse Voltage	V_r	5	V
Power Dissipation	P_d	500	mW
Operation Temperature Range	T_{op}	- 30 ~ + 85	$^\circ\text{C}$
Storage Temperature Range	T_{stg}	- 40 ~ + 100	$^\circ\text{C}$
Junction Temperature	T_j	120	$^\circ\text{C}$
Soldering Temperature	T_{sld}	Reflow Soldering: 260 $^\circ\text{C}$ /10sec Hand Soldering: 350 $^\circ\text{C}$ /3sec	

Optical Characteristics

Parameter	Symbol	Values	Unit
Viewing Angle	2ϕ	120	$^\circ$
Typ Color Rendering Index*	CRI	Min	Typ
		77	80

*CRI measurement tolerance is ± 1



Brightness Groups*

Group	Min Φ (lm) @ 65 mA	Max Φ (lm) @ 65 mA	Min Φ (lm) @ 120 mA	Max Φ (lm) @ 120 mA
F50	27	30	45	50
F55	30	33	50	55
F60	33	36	55	60
F65	36	39	60	65

*Brightness groups are tested at a tolerance of 10%

Voltage Groups*

Group	Min V_f (V) @ 65 mA	Max V_f (V) @ 65 mA	Min V_f (V) @ 120 mA	Max V_f (V) @ 120 mA
V1	2.7	2.8	2.9	3.0
V2	2.8	2.9	3.0	3.1
V3	2.9	3.0	3.1	3.2

* Voltage groups are tested at a tolerance of 0.05V

CCT Groups

Cool White

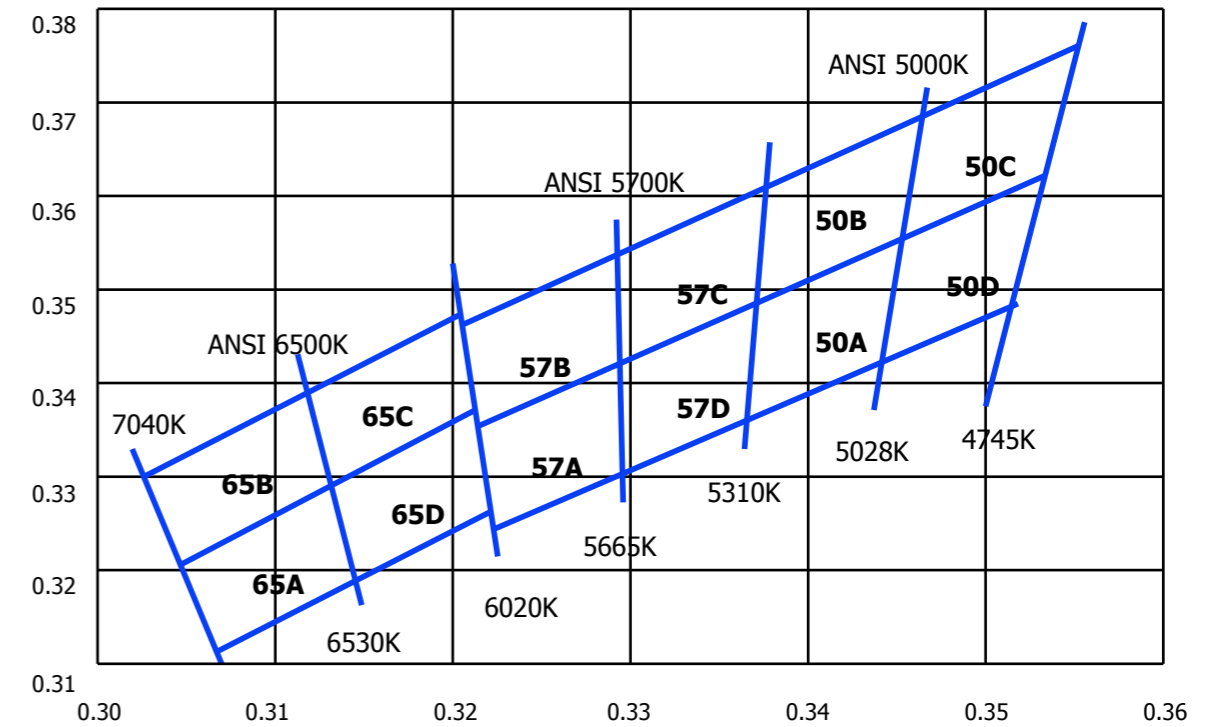

Bin Code	x	y	Bin Code	x	y	Bin Code	x	y
65A	0.3068	0.3113	57A	0.3222	0.3243	50A	0.3371	0.3493
	0.3145	0.3187		0.3294	0.3306		0.3452	0.3558
	0.3131	0.3290		0.3293	0.3423		0.3441	0.3428
	0.3048	0.3209		0.3215	0.3353		0.3366	0.3369
65B	0.3048	0.3209	57B	0.3215	0.3353	50B	0.3376	0.3616
	0.3131	0.3290		0.3293	0.3423		0.3464	0.3688
	0.3117	0.3393		0.3292	0.3539		0.3452	0.3558
	0.3028	0.3304		0.3207	0.3462		0.3371	0.3493
65C	0.3131	0.3290	57C	0.3292	0.3539	50C	0.3464	0.3688
	0.3213	0.3371		0.3293	0.3423		0.3551	0.3760
	0.3205	0.3481		0.3371	0.3493		0.3533	0.3624
	0.3117	0.3393		0.3376	0.3616		0.3452	0.3558
65D	0.3145	0.3187	57D	0.3294	0.3306	50D	0.3452	0.3558
	0.3221	0.3261		0.3366	0.3369		0.3533	0.3624
	0.3213	0.3371		0.3371	0.3493		0.3515	0.3487
	0.3131	0.3290		0.3293	0.3423		0.3441	0.3428

Neutral White

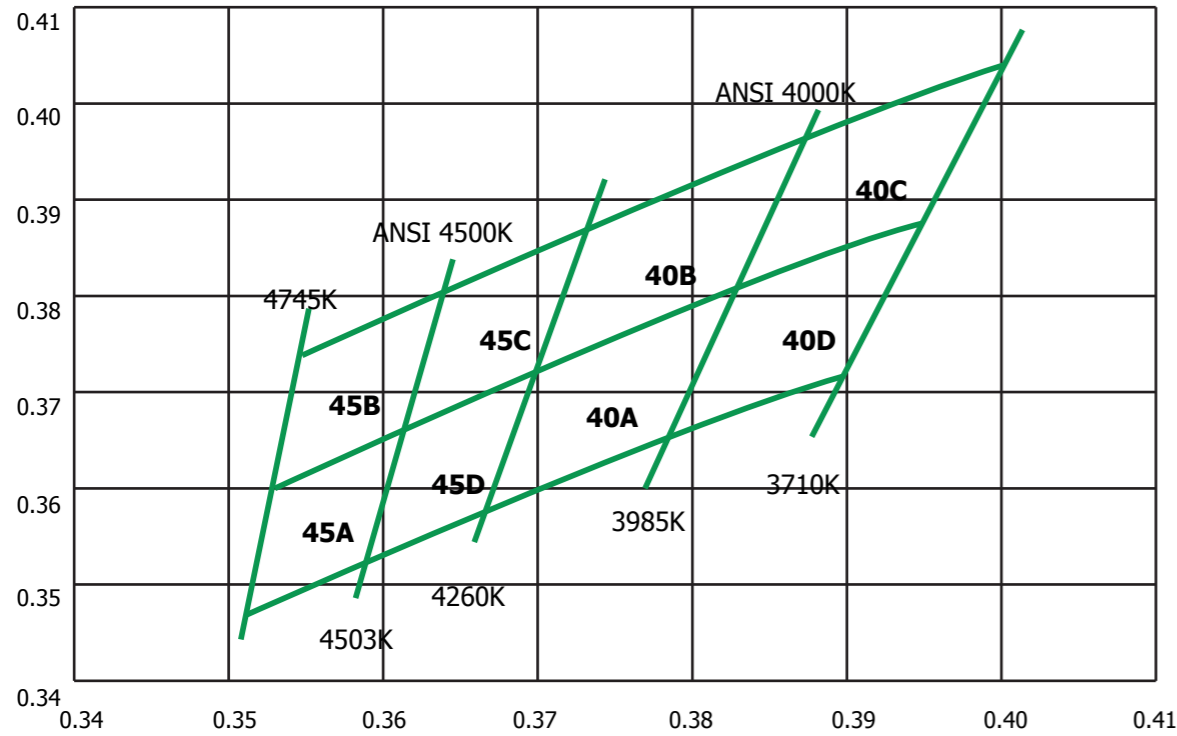

Bin Code	x	y
45A	0.3512	0.3465
	0.3530	0.3601
	0.3617	0.3663
	0.3591	0.3522
45B	0.3530	0.3601
	0.3548	0.3736
	0.3642	0.3805
	0.3617	0.3663
45C	0.3617	0.3663
	0.3642	0.3805
	0.3736	0.3874
	0.3703	0.3726
45D	0.3591	0.3522
	0.3617	0.3663
	0.3703	0.3726
	0.3670	0.3578

Bin Code	x	y
40A	0.3670	0.3578
	0.3703	0.3726
	0.3828	0.3803
	0.3784	0.3647
40B	0.3703	0.3726
	0.3736	0.3874
	0.3871	0.3959
	0.3828	0.3803
40C	0.3828	0.3803
	0.3871	0.3959
	0.4006	0.4044
	0.3952	0.3880
40D	0.3784	0.3647
	0.3828	0.3803
	0.3952	0.3880
	0.3898	0.3716

Warm White

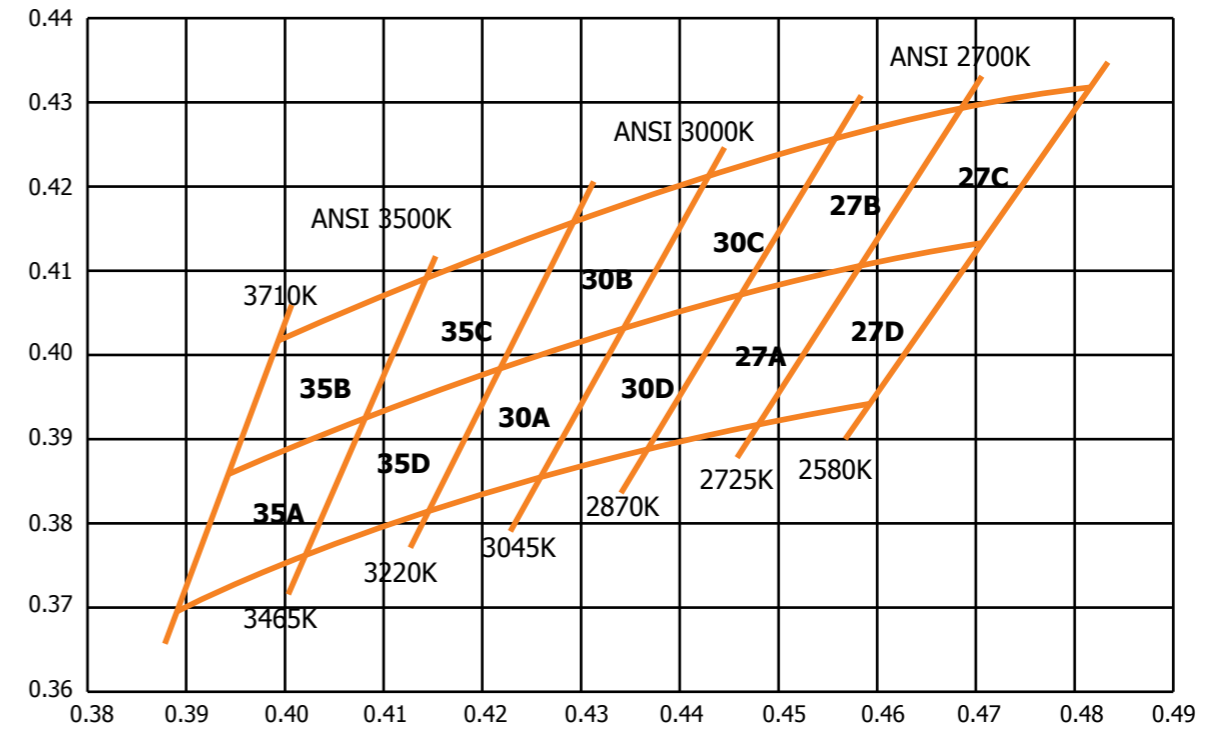

Bin Code	x	y
35A	0.3889	0.3690
	0.3943	0.3853
	0.4083	0.3921
	0.4018	0.3752
35B	0.3943	0.3853
	0.3996	0.4015
	0.4148	0.4090
	0.4083	0.3921
35C	0.4083	0.3921
	0.4148	0.4090
	0.4299	0.4165
	0.4223	0.3990
35D	0.4018	0.3752
	0.4083	0.3921
	0.4223	0.3990
	0.4147	0.3814

Bin Code	x	y
30A	0.4147	0.3814
	0.4223	0.3990
	0.4345	0.4033
	0.4260	0.3854
30B	0.4223	0.3990
	0.4299	0.4165
	0.4431	0.4213
	0.4345	0.4033
30C	0.4345	0.4033
	0.4431	0.4213
	0.4562	0.4260
	0.4468	0.4077
30D	0.4260	0.3854
	0.4345	0.4033
	0.4468	0.4077
	0.4373	0.3893

Bin Code	x	y
27A	0.4373	0.3898
	0.4468	0.4077
	0.4578	0.4104
	0.4483	0.3919
27B	0.4468	0.4077
	0.4562	0.4260
	0.4688	0.4290
	0.4578	0.4104
27C	0.4578	0.4101
	0.4688	0.4290
	0.4813	0.4319
	0.4703	0.4132
27D	0.4483	0.3919
	0.4578	0.4104
	0.4703	0.4132
	0.4593	0.3944

Package Dimensions

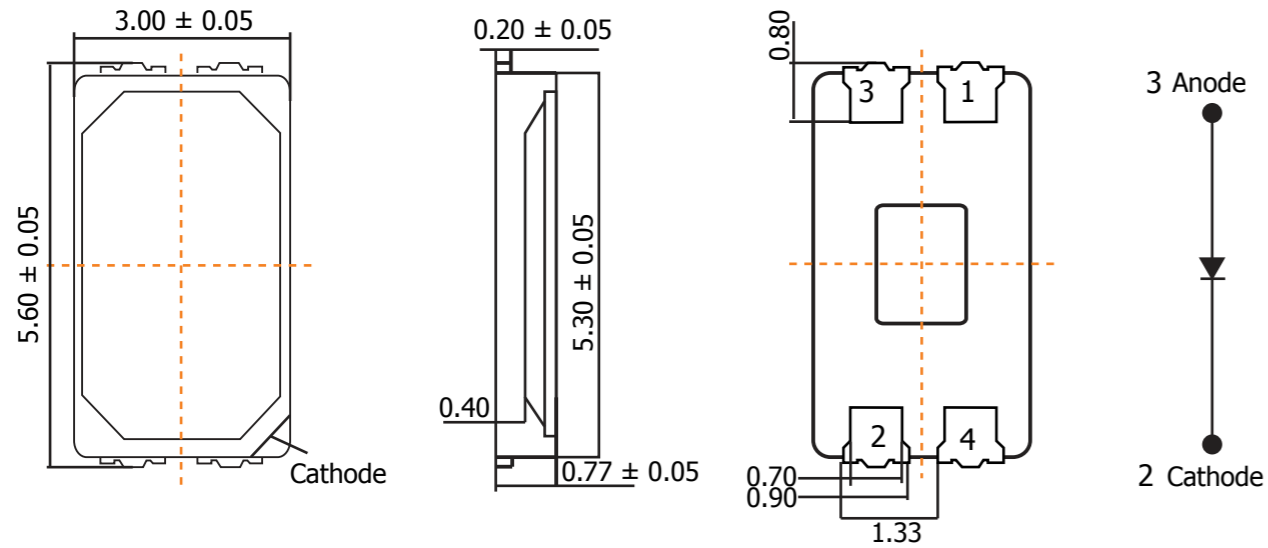

Notes:

1. Drawings are not to scale
2. All dimensions are all in millimeter
3. All dimensions without tolerance are for reference only

Solder Pad Design

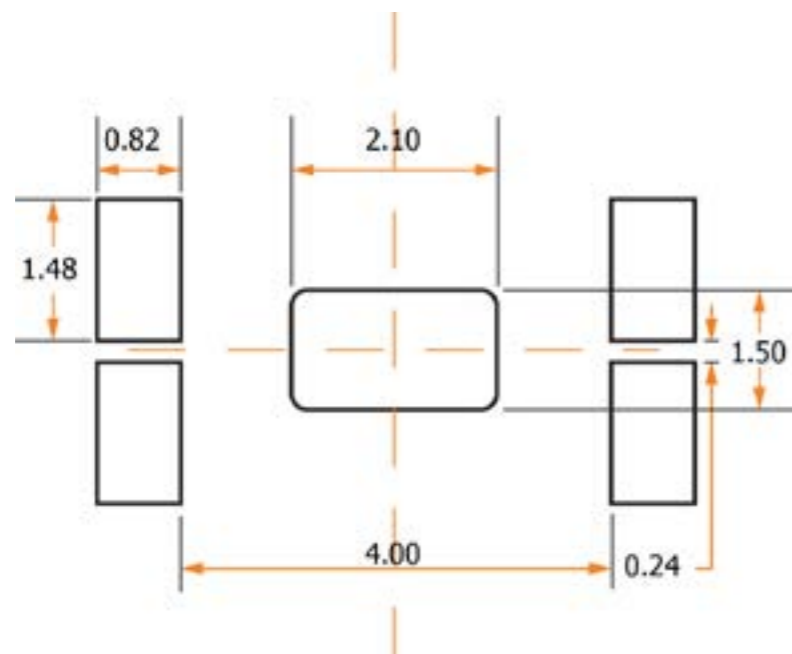

Relative Luminous Flux vs Forward Current

T_j=25°C

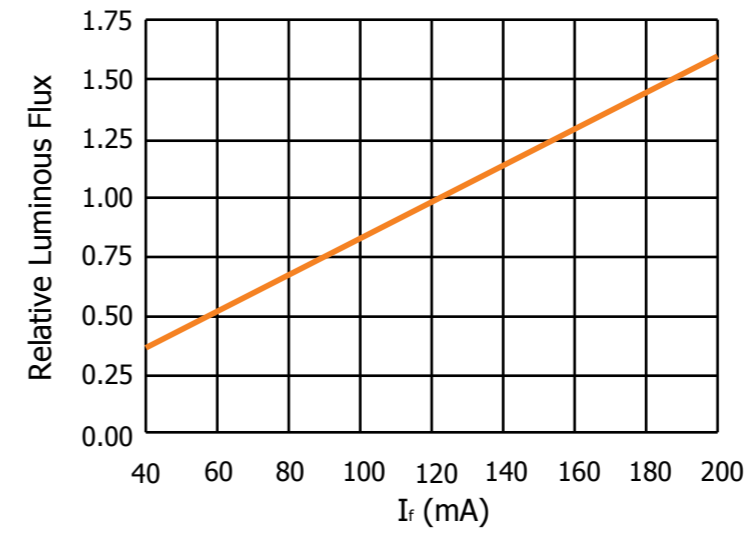

Forward Current vs Forward Voltage

T_j=25°C

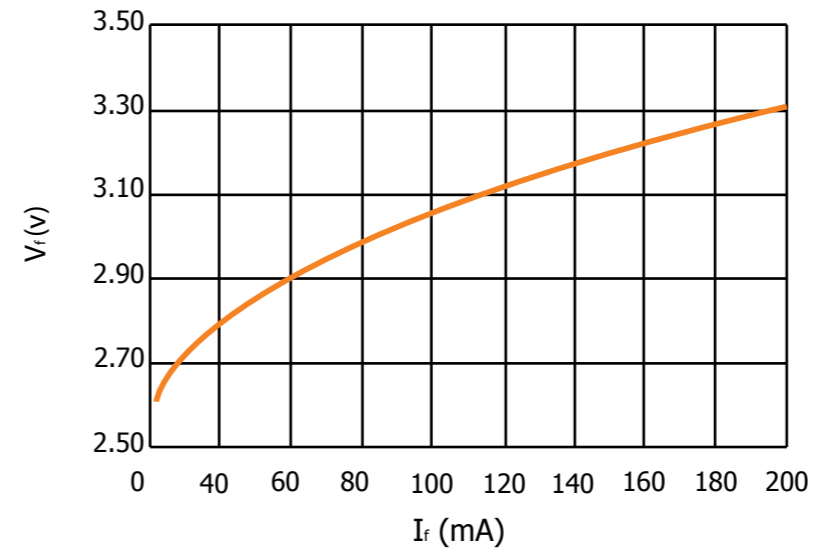

Relative Luminous Flux vs Junction Temperature

$I_f=120\text{mA}$

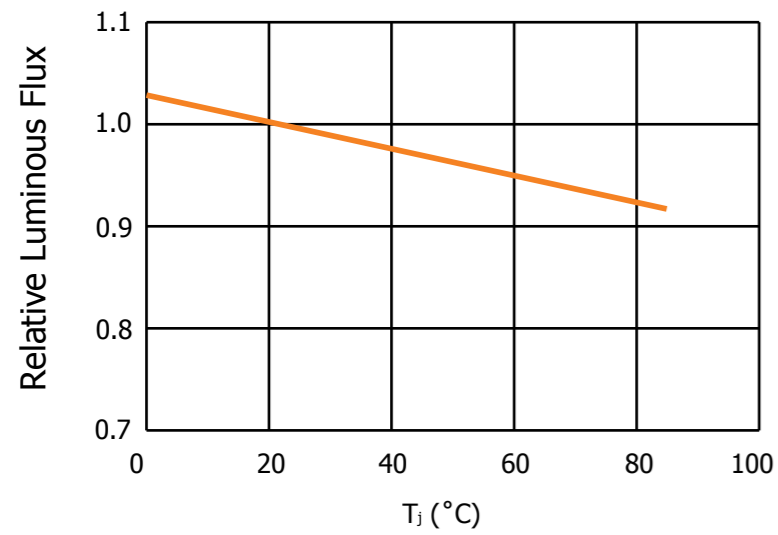

Forward Voltage vs Junction Temperature

$I_f=120\text{mA}$

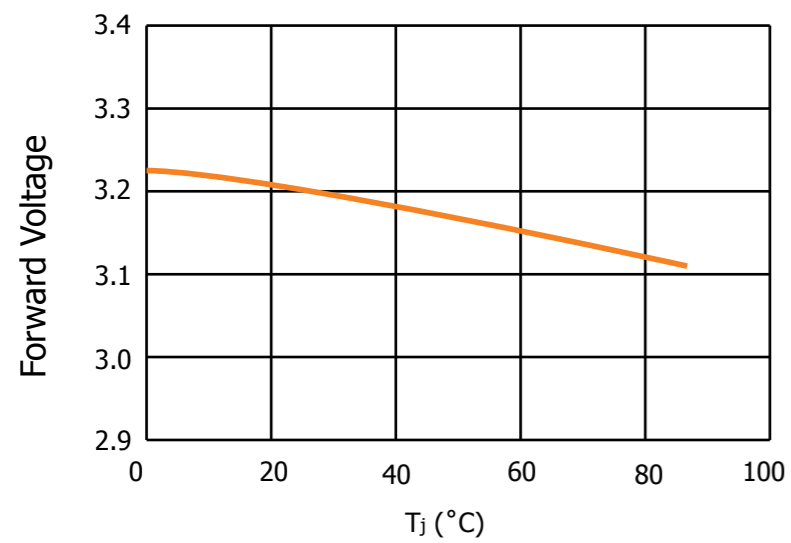

Spectral Characteristics

$T_j=25^\circ\text{C}$, $I_f=120\text{mA}$

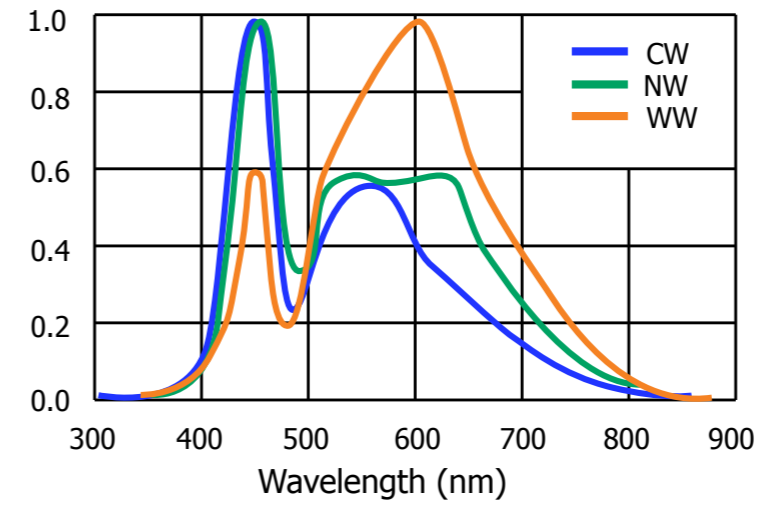

Radiation Characteristics

$T_j=25^\circ\text{C}$, $I_f=120\text{mA}$

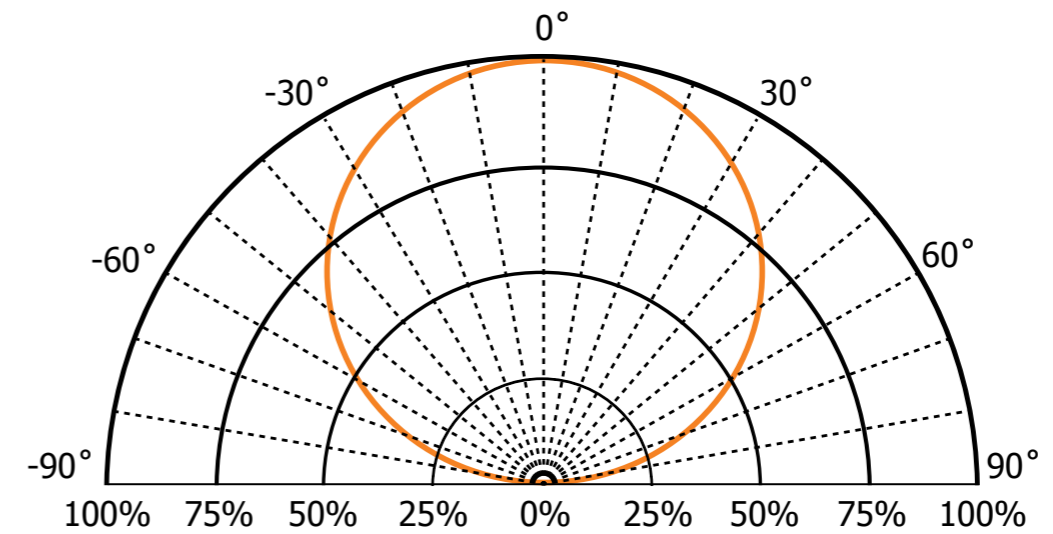

Chromaticity Coordinates Shift vs Forward Current

$T_j=25^\circ\text{C}$

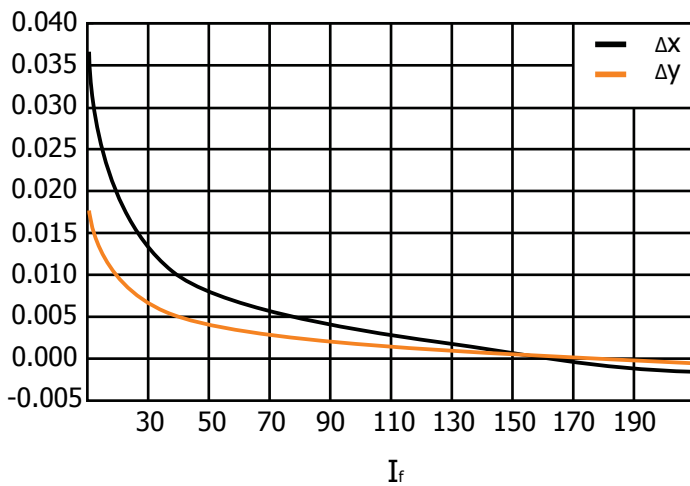

Chromaticity Coordinates Shift vs Junction Temperature

$I_f=120\text{mA}$

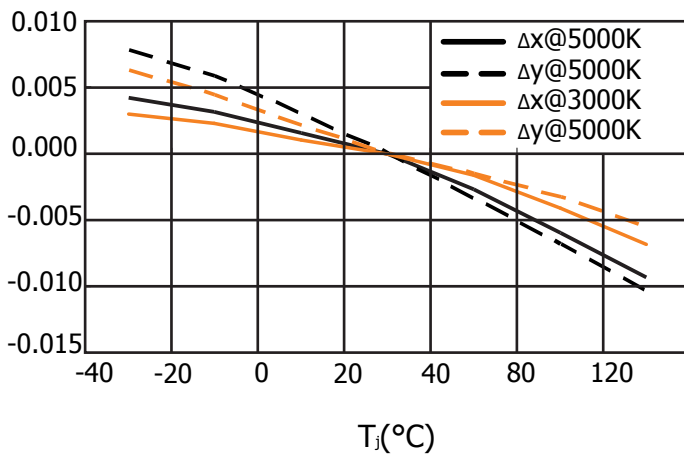

SVETLED

SVETLED SVL5630 Datasheet.
Copyright © 2011-2014 Svetel LLC. All rights reserved.
The information in this document subject to change without notice.
Web: www.svetled.org

Reflow Soldering Profile

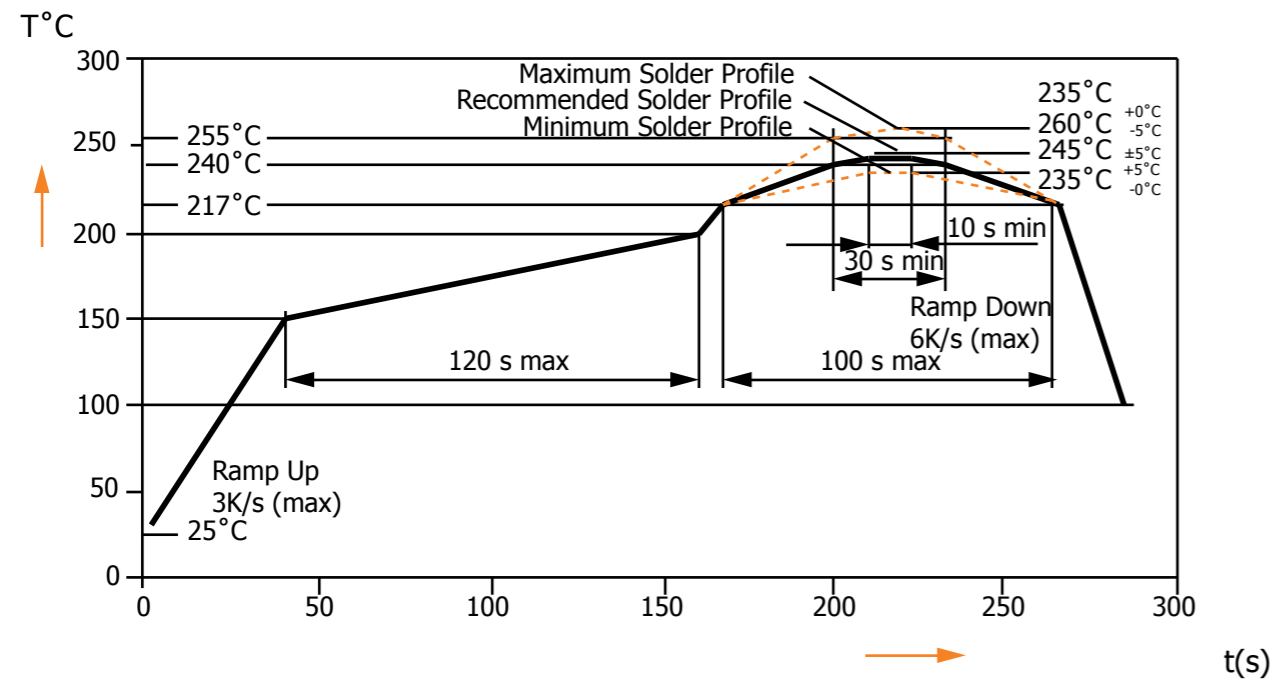

Lead Free Solder	
Pre-heat	150~200°C
Pre-heat time	120 sec max
Peak-Temperature	260°C max
Soldering time Condition	10 sec max

Notes:

1. The encapsulated material of the LEDs is silicone.
2. Precautions should be taken to avoid the strong pressure on the encapsulated part.
3. Please use the picking nozzle that does not affect the silicone resin.

Packing Information

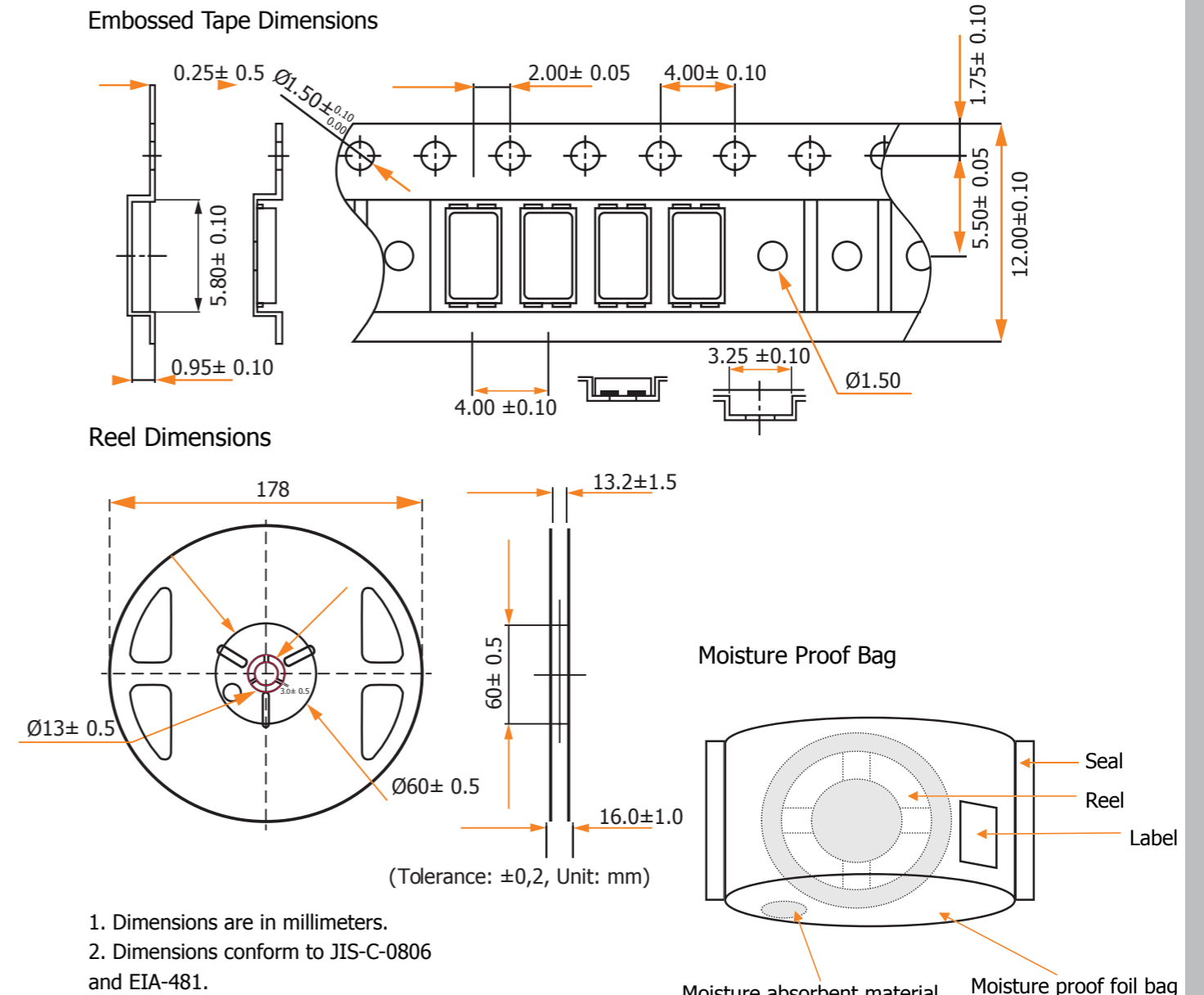

Packing unit

Package	Dimensions (mm)	No. of Reel/Unit	Q'ty (pcs)
Moisture proof foil bag		1 reel/bag	2000

Notes:

1. To avoid possible damages, it is recommended that the same packing arrangement should be used for future transportation.
2. Packing tolerance is ± 0.1%

Cautions

Correct handling and storage will ensure maximum lifetime.

(1) Moisture Proof Package

Moisture proof bags are used for product delivery. We recommend using the original moisture proof bag after opening with a functioning desiccant such as silica gel.

(2) Storage

The recommended shelf lifetime of unopened LEDs is six months.

LEDs should be soldered within 7 days of opening. It is recommended to store those unused LEDs in the original moisture proof bag with a functioning desiccant such as silica gel.

If LEDs have absorbed moisture or have exceeded the recommended storage time, then the LEDs should be baked to ensure the moisture is removed.

Baking treatment: > 24 hours at $70^{\circ} \pm 5^{\circ}\text{C}$

Svetled LED electrode and lead frame are comprised of a silver plated copper alloy. Please avoid conditions which may cause the LED to corrode, tarnish or discolor. This corrosion or discoloration might lower solderability and might affect on optical characteristics.

Please avoid rapid transitions in ambient temperature, especially in high humidity environments where condensation can occur.

(3) Heat Generation

It is necessary to avoid intense heat generation and operate within the maximum ratings given in this specification.

(4) Cleaning

It is recommended to clean the LEDs using Isopropyl alcohol. When using other solvents, it should be confirmed beforehand whether the chosen solvents will dissolve the package or the resin.

Never clean the LEDs with the ultrasonic machines.

Freon solvents should not be used to clean LEDs.

(5) Static Electricity

Static electricity or surge voltage can be harmful to LEDs.

It is recommended that a wrist band or an anti-electrostatic glove be used when handling the LEDs.

All devices, equipment and machinery must be properly grounded.

It is recommended that measures be taken against surge voltage on all mounting equipment.

When inspecting the final products in which LEDs were assembled, it is recommended to check whether the assembled LEDs are damaged by static electricity or not. Simple but effective tests can identify damaged LEDs such as a light-on test or a VF test at a lower current (below 1 mA is recommended). Damaged LEDs will show abnormal characteristics such as large increase of leak current as the forward voltage becomes lower, or the LEDs will not light at low current.

Criteria: ($V_f > 2.0\text{V}$ at $I_f=0.5\text{mA}$)

(6) Other

Care must be taken to ensure that the reverse voltage will not exceed the absolute maximum rating when using the LEDs with matrix drive.

The LED light output is strong enough to injure human eyes. Precautions must be taken to prevent looking directly at the LEDs without eye protection.

The LEDs described in this brochure are intended to be used for ordinary electronic equipment. LED devices used in applications in which exceptional quality and reliability are required, particularly when the failure or malfunction of the LEDs may directly jeopardize life or health, must be expressly authorized. Due to the manufacturing processes of LEDs, the typical data or calculated correlations of technical parameters can only reflect statistical calculations. Svetled reserves the right to modify these specifications as it deems necessary.